

HOOGWERKER VERHUUR

SCHAARHOOGWERKER

JLG 2030 ES

werkhoogte	8,1 m
Platform L x B	0,76x2,3 m
Beugel ondersteuning L x B	-
Apparaat afmetingen. L / B / H netto gewicht	2,3x0,76x1,82 m 2065 kg
Personen	2
netto belasting	360 kg
platformverlenging	0,9 m
proportionele regeling	-

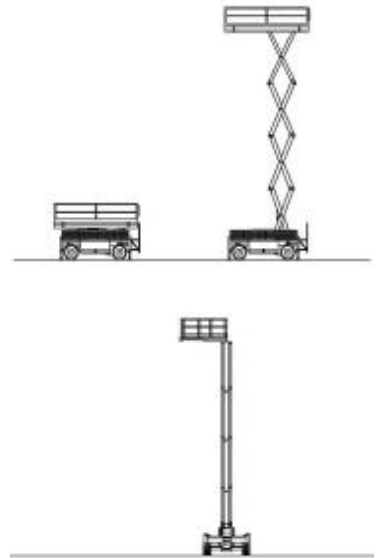

€ 45,- per dag

€ 110,- per week

€ 400,- per maand

3 % verzekeringstoeslag over het netto huurbedrag.

TELESCOOP

Manitou 150 AET

werkhoogte	14,85 m
Platform L x B	1,5x0,8 m
Beugel ondersteuning L x B	-
Apparaat afmetingen. L / B / H netto gewicht	- 7085 kg
Bereik horizontaal	8,9 m
Personen	2
netto belasting	230 kg
proportionele regeling	-
Max klimvermogen	-

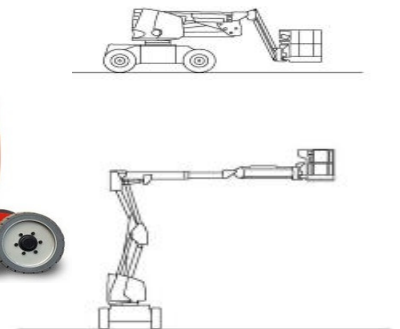

€ 145,- per dag

€ 350,- per week

€ 1.260,- per maand

3 % verzekeringstoeslag over het netto huurbedrag.

SCHAARHOOGWERKER

UpRight X 32

werkhoogte	11,8 m
Platform L x B	2,21x1,17 m
Beugel ondersteuning L x B	-
Apparaat afmetingen. L / B / H netto gewicht	- 2531 kg
Personen	-
netto belasting	318 kg
platformverlenging	0,9 m

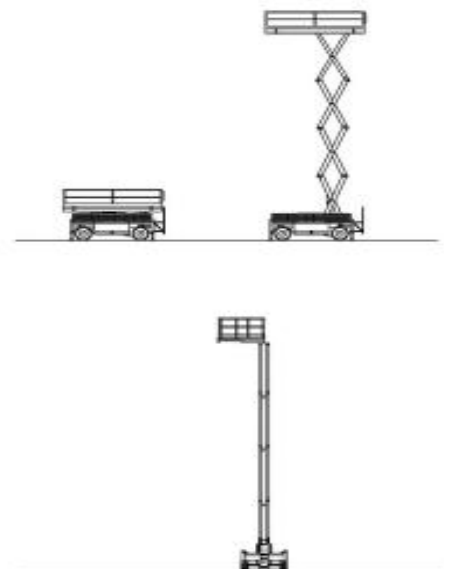

€ 100,- per dag

€ 250,- per week

€ 900,- per maand

3 % verzekeringstoeslag over het netto huurbedrag.

Knik Telescoop hoogwerker DIESEL 16m

Manitou 160 ATJ

werkhoogte	16,25 m
Platform L x B	1,8x0,8 m
Beugel ondersteuning L x B	-
Apparatuur afmetingen. L / B / H	5x2,3x2,37 m
netto gewicht	7450 kg
Bereik horizontaal	9,1 m
Personen	2
netto belasting	230 kg
proportionele regeling	-
Max klimvermogen	-

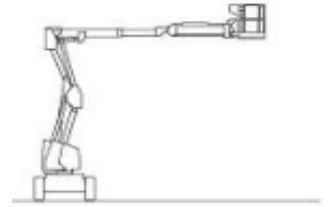

€ 170,- per dag

€ 427,- per week

€ 1.375,- per maand

3 % verzekeringstoeslag over het netto huurbedrag.

Knik Telescoop hoogwerker DIESEL 21m

JLG 600 AJ

werkhoogte	20,46 m
Platform L x B	0,91 x 1,83m
Beugel ondersteuning L x B	-
Apparatuur afmetingen. L / B / H	8,82 x 2,45 x 2,56 m
netto gewicht	10830 kg
Bereik horizontaal	11,81 m
Personen	2
netto belasting	230 kg
proportionele regeling	-
Max klimvermogen	45%

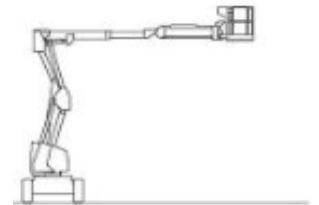

€ 232,- per dag

€ 612,- per week

€ 1.960,- per maand

3 % verzekeringstoeslag over het netto huurbedrag.

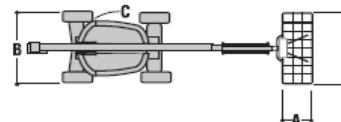
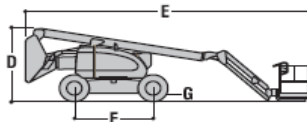
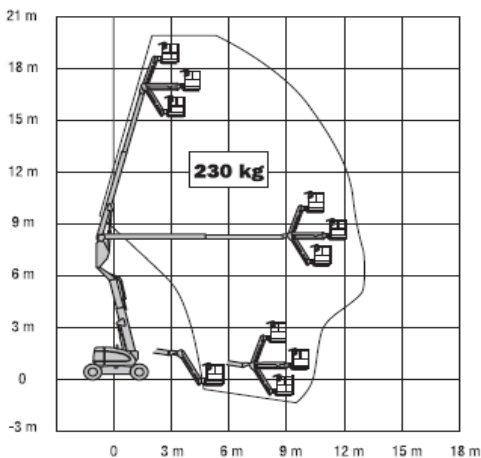

Verreiker Caterpillar 7.2 m diesel

TH330B

Laadvermogen	3500 kg
Hefhoogte	7.20 m
Laadgewicht op max. hefhoogte	2000 kg
Bereik horizontaal	3.82 m
Maximaal laadgewicht horizontaal	1250 kg
Apparaat afmetingen. L / B / H	4,69 x 2.35 x 2.27 m
netto gewicht	7200 kg
doorrijhoogte	2.27 m
maximum snelheid	40 km/h

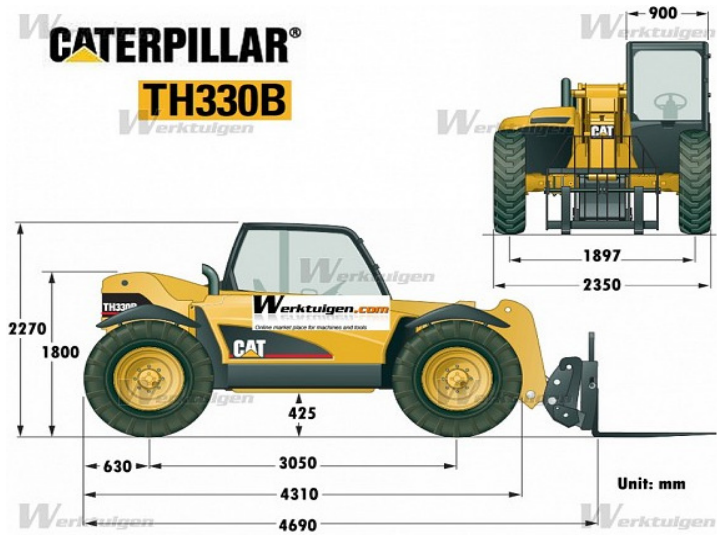

€ 195,- per dag

€ 575,- per week

€ 1.650,- per maand

3 % verzekeringstoeslag over het netto huurbedrag.

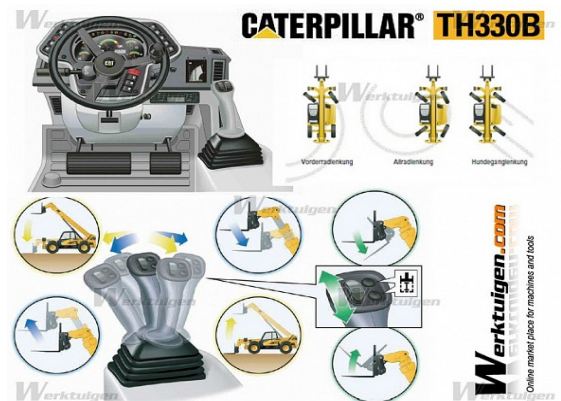
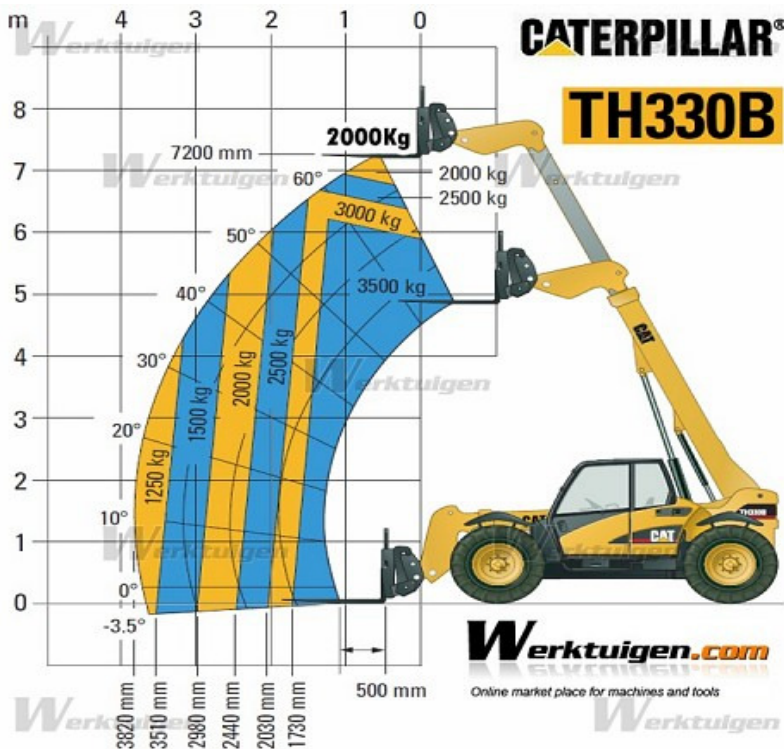

VLAARDINGEN - TEL: 010 435 72 73

Disclaimer: Deze specificaties kunnen niet exact overeenkomen met dit machine model, zij dienen alleen te worden gebruikt als richtlijn.